

# Panasonic®

## OPERATING INSTRUCTIONS

### Wireless Display

Model No. **CF-08**

## Contents

### Getting Started

Introduction.....	2	Description of Parts.....	14
Read Me First.....	3	First-time Operation.....	17
Precautions.....	10		

### Basic Operation

Starting Up/Shutting Down.....	29	Battery Power.....	36
LCD (Touchscreen) .....	33		

### Useful Information

Buttons.....	38	SD Memory Card.....	48
Quick Menu.....	39	Bluetooth .....	49
Software Keyboard .....	41	Control Panel.....	53
Signature Capture.....	47	For Effective Use.....	54

### Troubleshooting

Troubleshooting .....	55
-----------------------	----

### Appendix

LIMITED USE LICENSE AGREEMENT... 58	LIMITED WARRANTY .....	64
Specifications.....	62	

Please read these instructions carefully before using this product and save this manual for future use.

# Introduction

Thank you for purchasing this Panasonic wireless display. For optimum performance and safety, please read these instructions carefully.

## ■ Terms and illustrations in these instructions

<b>CAUTION</b>	:	Conditions that may result in minor or moderate injury.
<b>NOTE</b>	:	Useful and helpful information.
<b>→</b>	:	Page in these Operating Instructions.

- Some illustrations are simplified to help your understanding and may look different from the actual unit.
- Refer to the catalogs, etc. for the latest information about optional products.

## ■ Copyright

This manual is copyrighted by Matsushita Electric Industrial Co., Ltd. with all rights reserved. No part of this manual may be reproduced in any form without the prior written permission of Matsushita Electric Industrial Co., Ltd.

No patent liability is assumed with respect to the use of the information contained herein.

© 2006 Matsushita Electric Industrial Co., Ltd. All Rights Reserved.

## ■ Disclaimer

Wireless display specifications and manuals are subject to change without notice. Matsushita Electric Industrial Co., Ltd. assumes no liability for damage incurred directly or indirectly from errors, omissions or discrepancies between the wireless display and the manuals.

## ■ Trademarks

Microsoft<sup>®</sup>, Windows<sup>®</sup> and the Windows logo are registered trademarks of Microsoft Corporation of the United States and/or other countries.

SD Logo is a trademark.



Citrix<sup>®</sup> and ICA<sup>®</sup> protocol are registered trademarks of Citrix Systems, Inc.

Bluetooth<sup>™</sup> is a trademark owned by Bluetooth SIG, Inc., U.S.A. and licensed to Matsushita Electric Industrial Co., Ltd.

Panasonic<sup>®</sup> is a registered trademark of Matsushita Electric Industrial Co., Ltd.

Names of products, brands, etc., appearing in this manual are trademarks or registered trademarks of their respective own companies.

# Read Me First

## Information to the User

### **This product and your Health**

This product, like other radio devices, emits radio frequency electromagnetic energy. The level of energy emitted by this product however is far much less than the electromagnetic energy emitted by wireless devices like for example mobile phones.

Because this product operates within the guidelines found in radio frequency safety standards and recommendations, we believe this product is safe for use by consumers. These standards and recommendations reflect the consensus of the scientific community and result from deliberations of panels and committees of scientists who continually review and interpret the extensive research literature.

In some situations or environments, the use of this product may be restricted by the proprietor of the building or responsible representatives of the organization.

These situations may for example include:

- Using this product on board of airplanes, or
- In any other environment where the risk of interference to other devices or services is perceived or identified as harmful.

If you are uncertain of the policy that applies on the use of wireless devices in a specific organization or environment (e.g. airports), you are encouraged to ask for authorization to use this product prior to turning on the product.

### **Regulatory Information**

We are not responsible for any radio or television interference caused by unauthorized modification of this product. The correction of interference caused by such unauthorized modification will be the responsibility of the user. We and its authorized resellers or distributors are not liable for damage or violation of government regulations that may arise from failing to comply with these guidelines.

## Informations destinées aux utilisateurs

### **Ce produit et votre santé**

Ce produit, comme tout autre appareil radio, émet de l'énergie radioélectrique. Toutefois, la quantité d'énergie émise par ce produit est beaucoup moins importante que l'énergie radioélectrique émise par des appareils sans fil tels que les téléphones portables.

L'utilisation de ce produit ne comporte aucun risque pour le consommateur du fait que cet appareil opère dans les limites des directives concernant les normes et les recommandations de sécurité sur les fréquences radio. Ces normes et recommandations reflètent le consensus de la communauté scientifique et résultent de

# Read Me First

délibérations de jurys et comités de scientifiques qui examinent et interprètent continuellement les nouveautés de la vaste littérature sur les recherches effectuées. Dans certaines situations ou environnements, l'utilisation de ce produit peut être restreinte par le propriétaire du bâtiment ou par les représentants responsables de l'organisation. Ces situations peuvent être les suivantes par exemple :

- À bord d'un avion, ou
- Dans tout autre environnement où les risques d'interférence sur d'autres appareils ou services sont perçus ou identifiables comme dangereux.

Si vous n'êtes pas sûr de la réglementation applicable à l'utilisation d'appareils sans fil dans une organisation ou un environnement spécifiques (par exemple dans un aéroport), nous vous invitons à demander l'autorisation d'utiliser ce produit avant sa mise en marche.

## Informations concernant la réglementation

Nous déclinons toute responsabilité pour toute interférence radio ou télévision causée par des modifications non autorisées apportées à ce produit. La correction d'interférences causées par de telles modifications non autorisées sera la seule responsabilité de son utilisateur. Nous-mêmes, les revendeurs officiels et les distributeurs ne sommes pas responsable de tout dégât ou de toute violation des règlements de l'État pouvant découler du non-respect de ces directives.

## Information on Disposal for Users of Waste Electrical & Electronic Equipment (private households)



This symbol on the products and/or accompanying documents means that used electrical and electronic products should not be mixed with general household waste. Please dispose of this item only in designated national waste electronic collection schemes, and not in the ordinary dust bin.

## For business users in the European Union

If you wish to discard electrical and electronic equipment, please contact your dealer or supplier for further information.

## Information on Disposal in other Countries outside the European Union

This symbol is only valid in the European Union.

If you wish to discard this product, please contact your local authorities or dealer and ask for the correct method of disposal.

## Informations relatives à l'évacuation des déchets, destinées aux utilisateurs d'appareils électriques et électroniques (appareils ménagers domestiques)



Lorsque ce symbole figure sur les produits et/ou les documents qui les accompagnent, cela signifie que les appareils électriques et électroniques ne doivent pas être jetés avec les ordures ménagères.

Pour que ces produits subissent un traitement, une récupération et un recyclage appropriés, envoyez-les dans les points de collecte désignés, où ils peuvent être déposés gratuitement.

Dans certains pays, il est possible de renvoyer les produits au revendeur local en cas d'achat d'un produit équivalent.

En éliminant correctement ce produit, vous contribuerez à la conservation des ressources vitales et à la prévention des éventuels effets négatifs sur l'environnement et la santé humaine qui pourraient survenir dans le cas contraire.

Afin de connaître le point de collecte le plus proche, veuillez contacter vos autorités locales.

Des sanctions peuvent être appliquées en cas d'élimination incorrecte de ces déchets, conformément à la législation nationale.

### Utilisateurs professionnels de l'Union européenne

Pour en savoir plus sur l'élimination des appareils électriques et électroniques, contactez votre revendeur ou fournisseur.

### Informations sur l'évacuation des déchets dans les pays ne faisant pas partie de l'Union européenne

Ce symbole n'est reconnu que dans l'Union européenne.

Pour supprimer ce produit, contactez les autorités locales ou votre revendeur afin de connaître la procédure d'élimination à suivre.

## Models for U.S.A.

### Federal Communications Commission Radio Frequency Interference Statement

Note: This equipment has been tested and found to comply with the limits for a Class B digital device, pursuant to Part 15 of the FCC Rules. These limits are designed to provide reasonable protection against harmful interference in a residential installation. This equipment

generates, uses and can radiate radio frequency energy and, if not installed and used in accordance with the instructions, may cause harmful interference to radio communications. However, there is no guarantee that interference will not occur in a particular installation. If this equipment does cause harmful interference to radio or television reception, which can be determined by turning the equipment off and

# Read Me First

on, the user is encouraged to try to correct the interference by one or more of the following measures:

- Reorient or relocate the receiving antenna.
- Increase the separation between the equipment and receiver.
- Connect the equipment into an outlet on a circuit different from that to which the receiver is connected.
- Consult the Panasonic Service Center or an experienced radio/TV technician for help.

## Warning

To assure continued compliance, use only shielded interface cables when connecting to a wireless display or peripheral. Also, any changes or modifications not expressly approved by the party responsible for compliance could void the user's authority to operate this equipment.

This device complies with Part 15 of the FCC Rules. Operation is subject to the following two conditions:

- (1) This device may not cause harmful interference, and
- (2) This device must accept any interference received, including interference that may cause undesired operation.

Responsible Party:

Panasonic Corporation of North America  
One Panasonic Way  
Secaucus, NJ 07094  
Tel No:  
1-800-LAPTOP5 (1-800-527-8675)

## FCC RF Exposure Warning:

- This equipment complies with FCC radiation exposure limits set forth for an uncontrolled environment.
- This equipment must be installed and operated in accordance with provided instructions and minimum 1.5 cm spacing must be provided between antenna and all person's body (excluding extremities of hands, wrist and feet) during wireless modes of operation.
- This transmitter must not be co-located or operated in conjunction with any other antenna or transmitter.

## Notice for the products using LCD

This product uses one or more fluorescent lamps containing a small amount of mercury. It also contains lead in some components. Disposal of these materials may be regulated in your community due to environmental considerations.

For disposal or recycling information please contact your local authorities, or the Electronics Industries Alliance:  
<<http://www.eiae.org/>>

## Models for U.S.A./Canada

### For Use in Motor Vehicle

Warning: Wireless display may be installed in a motor vehicle and visible to the driver only if used to support vehicle related functions such as vehicle information, system control, rear or side observation and navigation. If used for entertainment purpose, such as televi-

sion reception or video play, it must be installed to the rear of the driver's seat where it will not be visible, directly or indirectly, to the operator of the motor vehicle.

Check with individual state/provincial laws to determine lawful use of this product while operating within a motor vehicle.

### Pour L'utilisation Dans Un Véhicule Motorisé

Avertissement : L'écran déporté sans fil peut être installé dans un véhicule motorisé et dans le champ de vision du conducteur uniquement en tant que dispositif d'aide aux fonctions du véhicule, comme par exemple pour fournir des informations sur le véhicule, comme dispositif de contrôle de système, pour l'observation à l'arrière ou sur les côtés du véhicule, ainsi que pour fournir de l'information routière.

Pour toute utilisation à fin de divertissement, comme par exemple pour regarder la télévision ou jouer à des jeux vidéo, il doit être installé à l'arrière du siège du conducteur, en un emplacement où il ne sera pas visible, ni directement ni indirectement, pour le conducteur du véhicule motorisé. Vérifiez les lois fédérales et nationales qui régissent l'utilisation légale de cet appareil à l'intérieur d'un véhicule motorisé.

## Models for Canada

### Industry Canada

This product complies with RSS210 Industry Canada.

Operation is subject to the following two conditions;

- (1) this device may not cause interference, and
- (2) this device must accept any interference, including interference that may cause undesired operation of the device.

## Models for Europe

### Declaration of Conformity (DoC)



"Hereby, we declare that this wireless display is in compliance with the essential requirements and other relevant provisions of the Directive 1999/5/EC."

Hint:

If you want to get a copy of the original DoC of our products which relates to the R&TTE, please contact to our web address: <http://www.doc.panasonic.de>

Contact:

Panasonic Services Europe

A Division of Panasonic Marketing Europe GmbH

Panasonic Testing Centre

---

### Compliance Notice - CE Mark

This equipment is in conformance with the requirements of the European Council Directive listed below:

73/23/EEC Low Voltage Directive with amendment 93/68/EEC

89/336/EEC EMC Directive with amendments 92/31/EEC and 93/68/EEC

1999/5/EC R&TTE

---

# Read Me First

Information of Countries intended for radio application:

The United Kingdom	The Netherlands	Sweden
The Federal Republic of Germany	France	Finland
The Kingdom of Belgium	Italy	Norway
The Swiss Confederation	Spain	Austria

## For Use in Motor Vehicle

Warning: Check the following Commission Recommendation to determine proper installation and usage of this product while operating within a motor vehicle. "Commission Recommendation on safe and efficient in-vehicle information and communication systems: A European statement of principles on human machine interface." Commission Recommendation is available from Official Journal of the European Communities.

## Models for U.K.

### Warning

#### **This apparatus must be earthed for your safety.**

To ensure safe operation the three-pin plug must be inserted only into a standard three-pin power point which is effectively earthed through the normal household wiring.

Extension cords used with the equipment must be three-core and be correctly wired to provide connection to earth. Wrongly wired extension cords are a major cause of fatalities.



The fact that the equipment operates satisfactorily does not imply that the power point is earthed and that the installation is completely safe.

For your safety, if you have any doubt about the effective earthing of the power point, consult a qualified electrician.

#### **FOR YOUR SAFETY PLEASE READ THE FOLLOWING TEXT CAREFULLY**

This appliance is supplied with a moulded three pin mains plug for your safety and convenience. A 3 amp fuse is fitted in this plug.

Should the fuse need to be replaced please ensure that the replacement fuse has a rating of 3 amps and that it is approved by ASTA or BSI to BS 1362.

Check for the ASTA mark  or the BSI mark  on the body of the fuse.

If the plug contains a removable fuse cover you must ensure that it is refitted when the fuse is replaced.

If you lose the fuse cover the plug must not be used until a replacement cover is obtained.

A replacement fuse cover can be purchased from your local Panasonic Dealer.

**IF THE FITTED MOULDED PLUG IS UNSUITABLE FOR THE SOCKET OUTLET IN YOUR HOME THEN THE FUSE SHOULD BE REMOVED AND THE PLUG CUT OFF AND DISPOSED OF SAFELY. THERE IS A DANGER OF SEVERE ELECTRICAL SHOCK IF THE CUT OFF PLUG IS INSERTED INTO ANY 13 AMP SOCKET.**

If a new plug is to be fitted please observe the wiring code as shown below. If in any doubt please consult a qualified electrician.

**Warning: THIS APPLIANCE MUST BE EARTHED.**

### Important

The wires in this mains lead are coloured in accordance with the following code:  
Green-and-yellow: Earth



Blue: Neutral  
Brown: Live

As the colours of the wires in the mains lead of this apparatus may not correspond with the coloured markings identifying the terminals in your plug, proceed as follows:

The wire which is coloured GREEN-and-YELLOW must be connected to the terminal in the plug which is marked by the letter E or by the safety earth symbol  coloured GREEN or GREEN-and-YELLOW.

The wire which is coloured Blue must be connected to the terminal which is marked with the letter N or coloured BLACK.

The wire which is coloured Brown must be connected to the terminal which is marked with the letter L or coloured RED.

The mains plug on this equipment must be used to disconnect the mains power. Please ensure that a socket outlet is available near the equipment and shall be easily accessible.

## ■ How to replace the fuse

Open the fuse compartment with a screwdriver and replace the fuse.

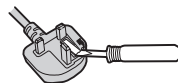

## Warnings

- This equipment is not designed for connection to an IT power system. (An IT system is a system having no direct connections between live parts and Earth; the exposed-conductive-parts of the electrical installation are earthed. An IT system is not permitted where the wireless display is directly connected to public supply systems in the U.K.)
- Disconnect the mains plug from the supply socket when the wireless display is not in use.

This equipment is produced to BS800/1983.

## Models for France and Italy

Communication using Bluetooth outdoor is against the law.  
Do not use Bluetooth outdoors.

## Pour la France

Bande de fréquences restreinte: Lors de l'utilisation de cet appareil sur le territoire français, vous ne pouvez le faire qu'en utilisant les bandes de fréquences 10 et 11 (respectivement 2.457 MHz et 2.462 MHz). L'utilisation de cet appareil sur une autre bande prise en charge par celui-ci est interdite. Une utilisation à l'extérieur n'est pas autorisée.

## Per l'Italia

Per l'uso negli interni è necessaria una licenza. L'uso con le installazioni esterne non è permesso.

# Precautions

## Wireless Display

### ■ Usage



#### **Avoid Extreme Heat and Cold**

Do not store or use the wireless display in locations exposed to heat, direct sunlight, or extreme cold.

Avoid moving the wireless display between locations with large temperature difference.

Operation: 5 °C to 35 °C  
{41 °F to 95 °F}

Storage: -20 °C to 60 °C  
{-4 °F to 140 °F}



#### **Avoid Direct Sunlight on the LCD Panel**

The LCD panel should not be exposed to direct sunlight or ultraviolet light.



#### **Avoid Humidity, Liquids and Dust**

Do not store or use the wireless display in locations exposed to high humidity, liquids (including rain) or dust.



#### **Prevent Shock**

Avoid subjecting the wireless display to severe vibrations or impact. Do not place the wireless display inside a car trunk.



#### **Avoid Radio Frequency Interference**

Do not place the wireless display near a television or radio receiver.



#### **Avoiding Low-temperature Burns**

Avoid more than casual contact with any heat producing area of the wireless display, AC adaptor, and any option or accessory you use with it. Even low heat, if warmer than body temperature, can cause a burn, if the skin is exposed to the heat source for a long enough period of time.



#### **Do Not Touch the Wireless Display and Cable When it Starts Thundering**



**Do Not Connect a Telephone Line, or a Network Cable Other Than the One Specified, into the LAN Port**

If the LAN port is connected to a network such as the ones listed below, a fire or electric shock may result.

- Networks other than 100BASE-TX or 10BASE-T.
- Phone lines [Telephone lines, internal phone lines (on-premise switches), digital public phones, etc.]



**Do Not Connect the AC Adaptor to a Power Source Other Than a Standard Household AC Outlet**

Connecting to a DC/AC converter (inverter) may damage the AC adaptor. On an airplane, only connect the AC adaptor/charger to an AC outlet specifically approved for such use.



**Keep SD Memory Cards Away From Infants and Small Children**

Accidental swallowing will result in bodily injury. In the event of accidental swallowing, see a doctor immediately.

■ **Handling**



**Avoid Magnetic Fields**

Keep the wireless display away from magnets. Data stored on the hard disk may be lost.



**Avoid Stacking**

Do not place heavy objects on top of the wireless display.



**Keep Small Objects Away**

Do not insert paper clips or other small objects into the wireless display.



**Do Not Disassemble the Wireless Display**

Do not attempt to disassemble your wireless display.



**Avoid Excessive Force on the Display**

Do not apply excessive downward force on the display, especially when plugs and/or cables are connected to the rear of the wireless display.

# Precautions

## Battery Pack

- Care should be exercised with regard to the following in order to avoid the possibility of overheating, fire or damage.



### **Avoid Heat**

Do not throw the battery pack into a fire or expose it to excessive heat.



### **Keep Articles Away**

Do not place the battery pack together with articles such as necklaces or hairpins when carrying or storing.



### **Do Not Disassemble**

Do not insert sharp objects into the battery pack, expose it to bumps or shocks, deform, disassemble, or modify it.



### **Do Not Short**

Do not short the positive (+) and negative (-) contacts.



### **Avoid Extreme Heat, Cold and Direct Sunlight**

Do not charge, use or leave the battery pack for extended periods where it will be exposed to direct sunlight, in a hot place (in a car on a sunny day, for example), or in a cold place.



### **Do Not Use With Any Other Equipment**

The battery pack is rechargeable and was intended for the specified equipment. Do not use it with any equipment other than the one for which it was designed.



### **Do Not Use This Wireless Display with a Battery Pack Other Than the One Specified**

Use only the specified Panasonic battery pack (CF-VZSU44U) with your CF-08. Use of batteries other than those manufactured and supplied by Panasonic may represent a safety hazard.



### **Do Not Put into a Microwave**

Do not put the battery pack into a microwave oven or a pressurized chamber.



## Stop Using

Should the battery emit an abnormal odor, become hot to the touch, become discolored, change shape, or become in any way different from normal, remove it from the wireless display and stop using it.

- Do not touch the terminals on the battery pack. The battery pack may no longer function properly if the contacts are dirty or damaged.
- Do not expose the battery pack to water, or allow it to become wet.
- If the battery pack will not be used for a long period of time (a month or more), charge or discharge (use) the battery pack until the remaining battery level becomes 30% to 40% and store it in a cool, dry place.
- This wireless display prevents overcharging of the battery by recharging only when the remaining power is less than approx. 95% of capacity.
- The battery pack is not charged when the wireless display is first purchased. Be sure to charge it before using it for the first time. When the AC adaptor is connected to the wireless display, charging begins automatically.
- Should the battery leak and the fluid get into your eyes, do not rub your eyes. Immediately flush your eyes with clear water and see a doctor for medical treatment as soon as possible.

---

## NOTE

- The battery pack may become warm during recharging or normal use. This is completely normal.
  - Recharging will not commence if internal temperature of the battery pack is outside of the allowable temperature range (0 °C to 45 °C {32°F to 122°F}). Once the allowable range requirement is satisfied, charging begins automatically. Note that the recharging time varies based on the usage conditions. (Recharging takes longer than usual when the temperature is 10 °C {50°F} or below.)
  - If the temperature is low, the operating time is shortened. Only use the equipment within the allowable temperature range.
  - The battery pack is a consumable item. If the amount of time the equipment can be run by using a particular battery pack becomes dramatically shorter and repeated recharging does not restore its performance, the battery pack should be replaced with a new one.
  - When transporting a spare battery inside a package, briefcase, etc., it is recommended that it be placed in a plastic bag so that its contacts are protected.
  - Always power off the equipment when it is not in use. Leaving the equipment on when the AC adaptor is not connected will exhaust the remaining battery capacity.
-

# Description of Parts

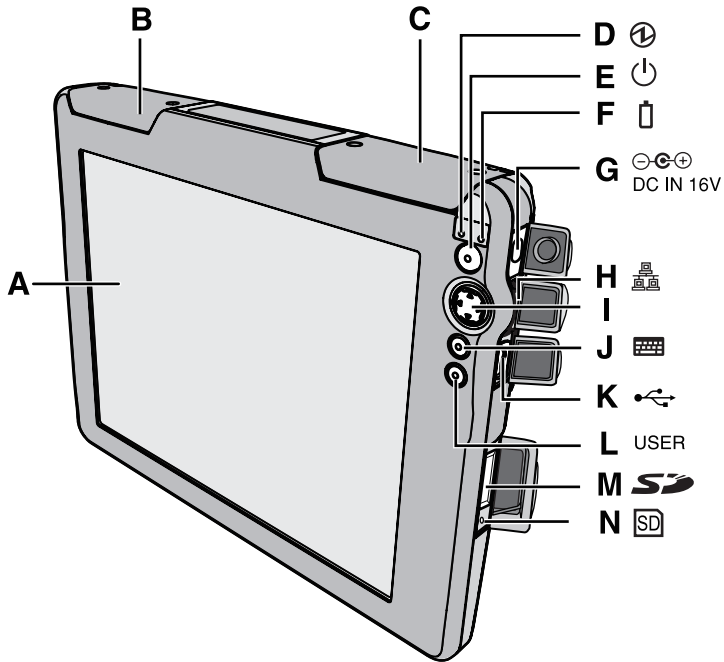

- A. LCD (Touchscreen)
- B. Wireless LAN antenna
- C. Bluetooth antenna
- D. Power status
- E. Power button
- F. Battery status
- G. DC-IN jack

- H. LAN port
- I. Cursor control button
- J. Keyboard button
- K. USB port
- L. USER button
- M. SD Memory Card slot
- N. SD Memory Card status

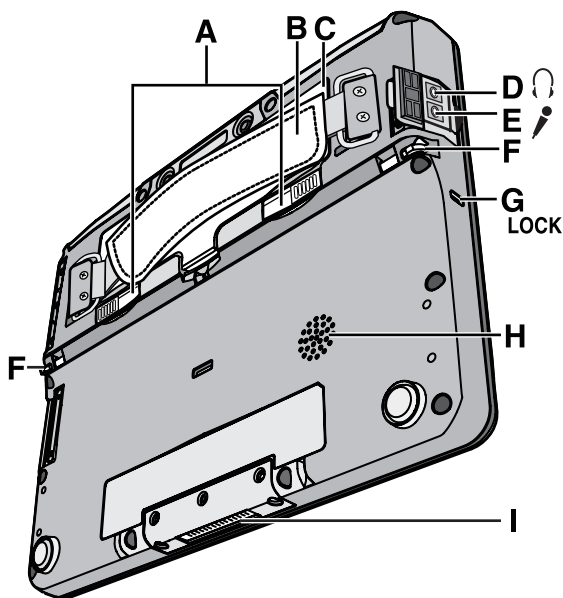

<Models for U.S./Canada>



A lithium ion battery that is recyclable powers the product you have purchased. Please call 1-800-8-BATTERY for information on how to recycle this battery.

L'appareil que vous vous êtes procuré est alimenté par une batterie au lithium-ion. Pour des renseignements sur le recyclage de la batterie, veuillez composer le 1-800-8-BATTERY.

**A. Battery cover latch**

**B. Hand strap**

Adjust the length of the belt so that the wireless display does not fall by mistake, and firmly hold the wireless display when using it.

**C. Battery pack**

**D. Headphone jack**

You can connect headphones or amplified speakers. When they are connected, audio from the internal speakers is not heard.

**E. Microphone jack**

Use only monaural condenser microphone (miniature jack). Connecting another type of microphone may interrupt audio input or may cause a malfunction.

**F. Stylus holder**

**G. Security lock**

You can connect a Kensington cable. Refer to the instruction manual of the cable.

**H. Speaker**

**I. Expansion bus connector**

**CAUTION**

- Do not put metallic objects or magnetic media close to the speaker.
- Do not touch the expansion bus connector. The wireless display may no longer function properly if the connector is dirty or damaged.

# Description of Parts

## Using the Tether

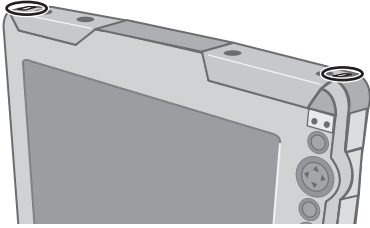

The tether can be attached to the upper right or upper left corner of the display. It prevents the pen (included) from falling accidentally.

## Attaching the Tether

1

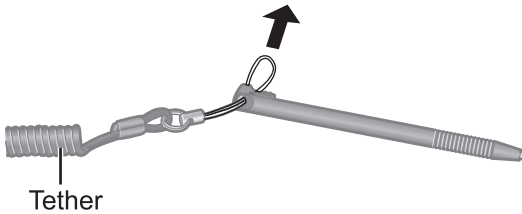

2

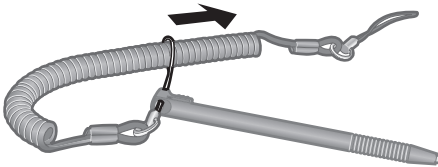

3

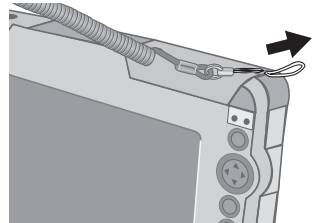

4

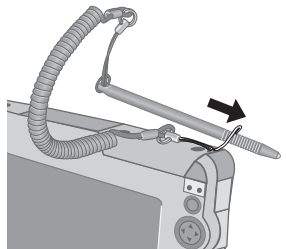



# First-time Operation

## ■ Preparation

① Check and identify the supplied accessories.

If you do not find the described accessories, contact your technical support office.

- AC adaptor ..... 1
- AC Cord ..... 1
- Battery Pack ..... 1

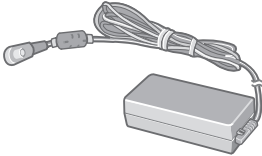

Model No.: CF-AA1623A

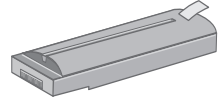
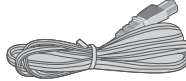

Model No.: CF-VZSU44

- Stylus ..... 1
- Cloth ..... 1



- Tether (→ page 16) ..... 1
- Operating Instructions (This book) ..... 1

② Read the LIMITED USE LICENSE AGREEMENT before breaking the seal on the wireless display's packaging (→ page 58).

## 1 Insert the battery pack.

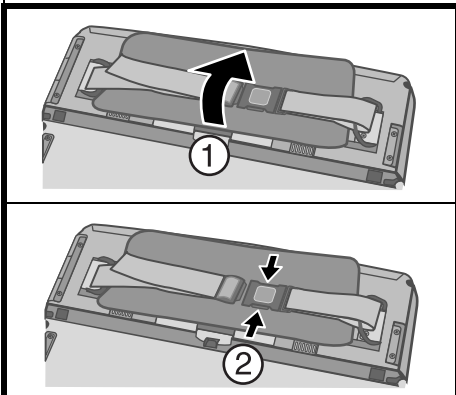

① Turn the wireless display over, and open the hand strap cover.

② Remove the hand strap.

# First-time Operation

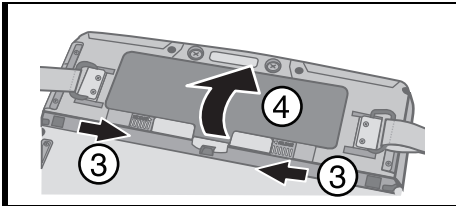

- ③ Slide the battery cover latch.
- ④ Open and remove the battery cover.

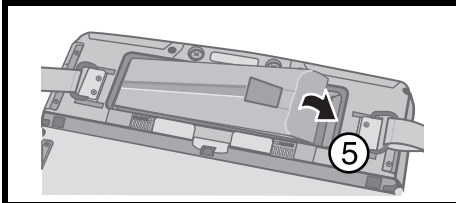

- ⑤ Firmly attach the battery pack to the connector.

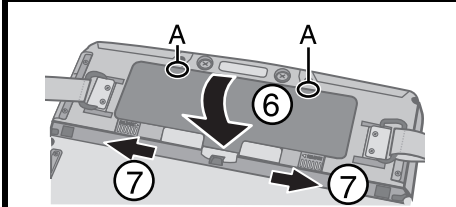

- ⑥ Fit the battery cover into (A), and then close the battery cover.
- ⑦ Slide the battery cover latch.

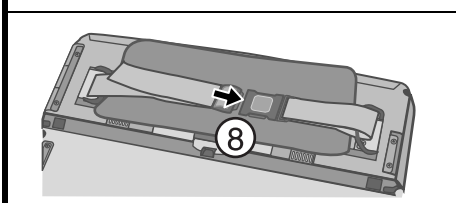

- ⑧ Attach the hand strap.

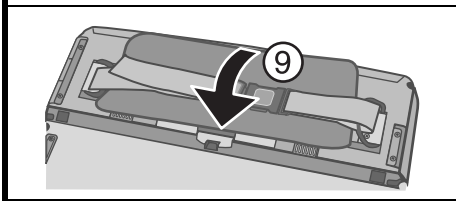

- ⑨ Attach the hand strap cover.

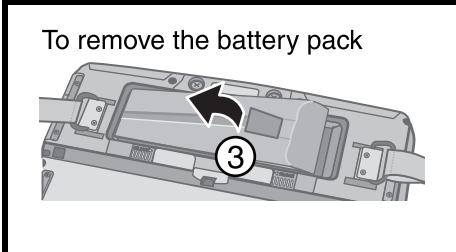

## ■ To remove the battery pack

- ① Slide the battery cover latch as in step ③ (→ above).
- ② Open the battery cover as in step ④ (→ above).
- ③ Pull the tab of the battery pack and remove it from the wireless display.

---

**CAUTION**

- Be careful not to catch the tab when you close the battery cover.
  - Make sure the cover is securely attached. Otherwise the battery pack may fall when you carry the wireless display.
  - Do not touch the terminals of the battery pack and the wireless display. Doing so can make the terminals dirty or damaged, and may cause malfunction of the battery pack and the wireless display.
  - Use only the specified battery pack (CF-VZSU44U) with your wireless display.
- 

## 2 Connect your wireless display to a power outlet.

The battery charging starts automatically.

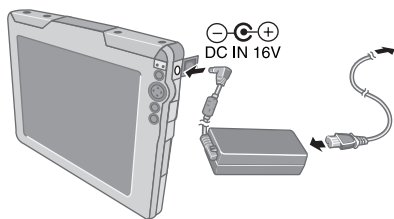

---



**CAUTION**

- When using the wireless display for the first time, do not connect any peripheral device except the battery pack and AC adaptor.
  - **Handling the AC adaptor**
    - Do not twist or pull the AC power cord forcefully. Doing so may damage the connections.
    - Use only the specified AC adaptor with your wireless display. Using an AC adaptor other than the one supplied might damage the battery and/or the wireless display.
    - When the DC plug is not connected to the wireless display, disconnect the AC cord from your AC wall outlet.
    - Problems such as sudden voltage drops may arise during periods of thunder and lightning. Since this could adversely affect your wireless display, an uninterruptible power source (UPS) is highly recommended unless running from the battery pack alone.
-

# First-time Operation

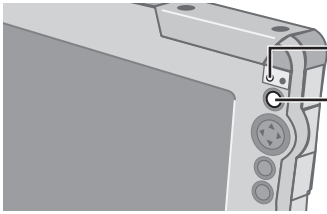
## 3 Turn on the wireless display.



Press the power button  for approximately one or two seconds until the power indicator  lights.

## 4 Calibrate the touchscreen.

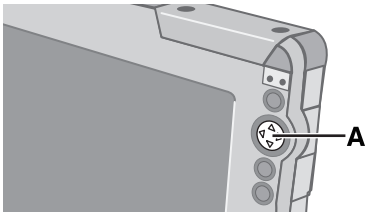

Touch the “+” marks on the calibration screen with the stylus (included) for about one second. After the calibration procedure is executed, press the center of the cursor control button (A).

## 5 Make the date and time setting.

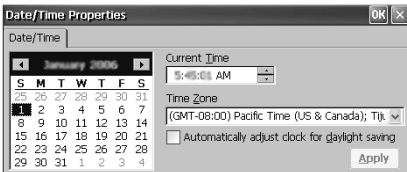

Set the current time and time zone, and then tap .

- For information about “tap”: → page 33

- You can use the software keyboard when you set the time.  
For information about how to use the Software Keyboard: → page 41
- If the [Date/Time Properties] screen does not appear automatically



Double-tap  on the desktop, and double-tap [Date/Time].

The [Date/Time Properties] screen will appear.

## 6 Make the network setting.

Before making the settings for the wireless display, check the following server settings.



- Is the remote desktop allowed to use?
- IP address and subnet mask (if the name server is inside the network, use the server name instead.)
- User name and password

<p>When making connections with a LAN</p> <ul style="list-style-type: none"> <li>● For the following operation, make sure the LAN is enabled. Tap [ETHERNET1], and then tap [File] - [Enable].</li> </ul> <p>The icon will change from  to </p>	<p>When making connections with a wireless LAN</p>
① Double-tap [ETHERNET1].	① Double-tap [WIRELESS LAN1].



② Tap the [IP address] tab, and set an IP address and subnet mask.	
If DHCP is available on the network	If DHCP is not available on the network
Select [Obtain an IP address via DHCP].	Select [Specify an IP address], and enter the IP address, subnet mask and if necessary, default gateway.



<p>③ Tap [OK].</p> <ul style="list-style-type: none"> <li>● When making connections with a wireless LAN</li> </ul> <p style="text-align: center;"></p> <p>① Double-tap  on the desktop, and then tap [Wireless LAN].</p> <p>② Tap the [Wireless Information] tab, and then tap the access point from the list. Now, select settings as follows according to your own network environment.</p> <p>③ Tap [Connect].</p>
---

# First-time Operation

## 7 Make the settings to connect the server.

The client used will differ depending on the server.

Server name	Client name
<ul style="list-style-type: none"><li>● Microsoft® Windows® XP Professional</li><li>● Microsoft® Windows® Server 2000</li><li>● Microsoft® Windows® Server 2003</li></ul>	Microsoft® Remote Desktop Connection
<ul style="list-style-type: none"><li>● Citrix® MetaFrame Presentation Server 3.0</li><li>● Citrix® Presentation Server 4.0</li></ul>	Citrix® ICA® Client
<ul style="list-style-type: none"><li>● Web server</li></ul>	Microsoft® Internet Explorer

### When making connections with Microsoft® Remote Desktop Connection

Perform the following procedure.

① Double-tap  on the desktop.

② Tap [Options].

③ Enter the following items.

- Computer: IP address or server name
- User name: Account name for the server
- Password: The password required to log on to the server
  - If a check mark is added for [Save my password], the password will be saved, and it will not be necessary to enter the password for subsequent connections.
- Domain: (If required, enter it.)

④ Tap [Save As].  
Enter the file name, select the save destination and tap .

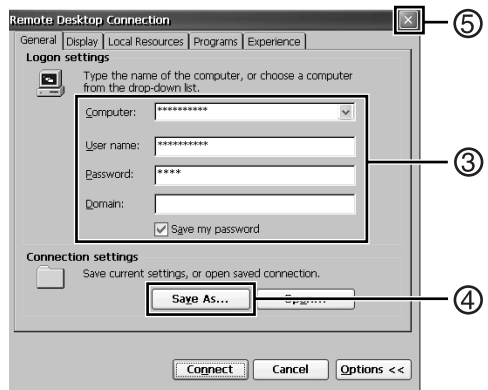

The settings made in step ①-④ will be saved, and  \*1 will appear on the desktop.  
XXX

\*1 The file name entered in step ④ will appear instead of "XXX".

⑤ Tap .

## When making connections with Citrix® ICA® Client

Perform the following procedure.

- ① Double-tap  on the desktop, and tap [Create New Connection].  
ICA Client
- ② Enter the IP address or server name for the connection destination in [Server or Published Application], and tap [Save].  
When the message appears, tap [Yes].
- ③ Select the name entered in step ②, and tap [Edit].
- ④ Tap [Edit Logon Information], enter Username and Password (and Domain, if required), and tap [Save].
- ⑤ Tap [Main] at the top of the screen.

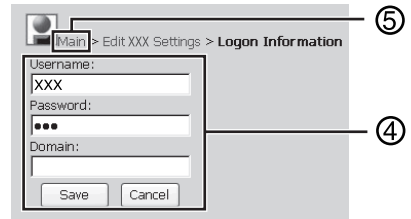



- ⑥ Select the name entered in step ② and tap [Edit].
- ⑦ Tap [Edit Title], add the check mark for [Create a Desktop shortcut], and tap [Save], then tap .

The settings made in step ①-⑦ will be saved, and \*1 will appear on the desktop.

\*1 The file name entered in step ② will appear instead of “XXX”.

## When making connections with Microsoft® Internet Explorer

Perform the following procedure.

- ① Double-tap  on the desktop, and then double-tap [Internet Options].  
Control Panel
- ② Make the necessary settings, then tap .

### 8 Make the security setting.

You can set the password and/or enable/disable some functions for security purpose.

# First-time Operation

You can set two types of users with different operating authorities.

Supervisor	User
Changes settings related to the wireless display operations, and controls the operations of the User.	Executes only operations that have been limited by the Supervisor.

The security setting screen can be displayed using the following procedure.

- ① Double-tap  Control Panel on the desktop.
- ② Double-tap [Security (Supervisor)].

[Supervisor] tab	[User] tab	[Device Permission] tab
Settings for the Supervisor	Settings for the User	Settings for the Supervisor and User

Here, we will explain the settings made by the Supervisor for the Supervisor and User.

## Setting the password

First, set the Supervisor Password using the following procedure.

- ① Tap the [Supervisor] tab.
- ② Enter your password in [New Password].
- ③ Enter your password again in [Confirm Password] and tap .
- ④ At the confirmation message, tap [Yes].

When the message that recommends executing Flash Backup appears, tap .

Next, set the User Password using the following procedure.

- ① Tap the [User] tab.
- ② Set the password.  
Refer to step ②-④ of the Supervisor Password setting. (→above)

### CAUTION

- Do not forget your password. If you forget your Supervisor Password, you will not be able to use your wireless display. Contact your technical support office.



**NOTE**

- The password will not be displayed on the screen.
- You can use up to 40 alphanumeric characters (excluding spaces).
- When the password has been set, you need to enter your password in [Current Password].
- To disable the password, leave the input field empty.
- Disabling the Supervisor Password also disables the User Password.

## Set the operating restrictions

The following settings can be made by tapping each tab.

### ■ [Supervisor] tab

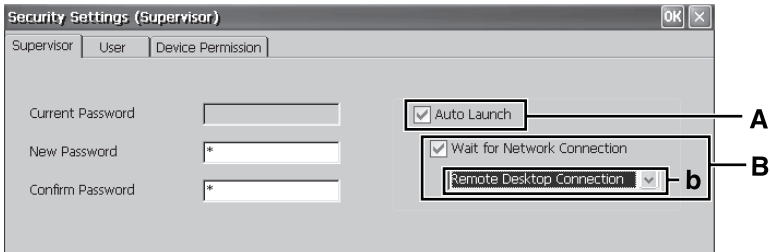

### ■ [User] tab

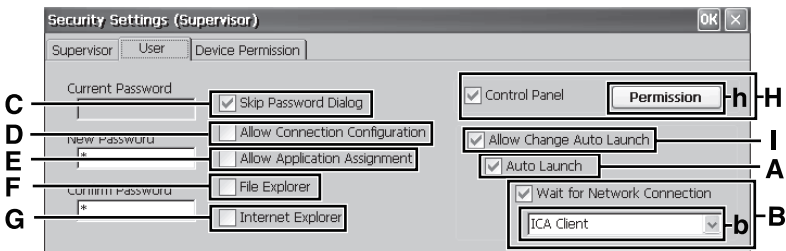

Add the check mark, and the settings will be enabled.

#### A. Auto Launch

When you select an application (b), that application will automatically start up when the wireless display is started.

- If the connection settings for Microsoft® Remote Desktop Connection or Citrix® ICA® Client have

been made in advance (→ page 22) and the check mark is added for [Wait for Network Connection] (B), you can set these applications to start up automatically.

#### B. Wait for Network Connection

An application (b) will launch after the network connection is build up.

# First-time Operation

## C. Skip Password Dialog

Allows the User to log on without entering a password.

When the User turns on the wireless display, the [Enter Password] screen is not displayed.

(If you press the power button with the USER button pressed, the [Enter Password] screen will be displayed, and the Supervisor can log on with the Supervisor Password.)

## D. Allow Connection Configuration

Allows the User to create and change connection settings.

To create the connection settings:  
→ page 22

## E. Allow Application Assignment

Allows the User to allocate applications to the keyboard button, USER button (→ page 38) and Quick Menu (→ page 39).

## F. File Explorer

Allows the User to view files via Win-

dows Explorer.





will be displayed on the desktop.

## ■ [Device Permission] tab

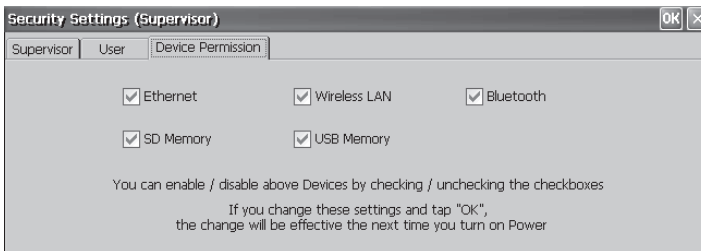
The following items cannot be used when the check mark is removed.



When all settings are complete, tap .

When the message that recommends executing Flash Backup appears, tap .

## G. Internet Explorer

Allows the User to access to the Web browser, and to create/change

connection settings.



will be displayed on the desktop.

## H. Control Panel

Allows the User to make various settings in Control Panel.

- You can set the items that the User is allowed to use with the following procedure.



- ① Tap [Permission] (h) to display the [Permission] screen.
- ② Add the check mark for only the items to be displayed in the [Control Panel] screen, and tap .

## I. Allow Change Auto Launch

Allows the User to change [Auto Launch] (A) setting.



## 9 Save the settings.

Settings made up to step 8 must be saved (backed up) using the following procedure. If the settings are not saved, they will be lost when the wireless display is turned off.

- ① Double-tap  on the desktop and double-tap [Flash Backup].  
Control Panel  
Confirm that your wireless display is connected to a power outlet. (→ page 19)
- ② Tap [Start Backup].  
Backing up data will start.
- ③ When the message “Backup successful.” appears, tap .

## Copying settings to another CF-08

Using the following procedure, you can copy the backed up settings to another CF-08 from an SD Memory Card or other media.

- ① Double-tap  on the desktop and double-tap [Flash Copy].  
Control Panel  
Confirm that your wireless display is connected to a power outlet. (→ page 19)
- ② Insert the copy destination media, and select the media in “Copy To.”
- ③ Enter the file name and tap [Copy Backup].  
Copying data will start.
  - The file that has already existed cannot be overwritten.  
In this case, tap , change the file name, and tap [Copy Backup].
- ④ When the message “Copy successful.” appears, tap .
- ⑤ Remove the media.

From step ⑥ onward are for CF-08 to which the original settings will be copied. Turn on the CF-08 to which the settings will be copied, and perform the following procedure.

- ⑥ Double-tap  on the desktop and then double-tap [ROM Update].  
Control Panel
- ⑦ Connect your wireless display to the power outlet. (→ page 19)

# First-time Operation

- ⑧ Insert the media containing the files copied in step ③-④, and then tap [Browse].
- ⑨ Select the file and tap .
- ⑩ Tap [Next].
- ⑪ Tap [Update Start].
- ⑫ When the confirmation message appears, tap [Yes].  
ROM Update will start.  
When ROM Update terminates, the wireless display will restart and the calibration screen will appear automatically. (→ page 20)

# Starting Up/Shutting Down

## Starting Up

### 1 Turn on the wireless display.

When you log on as a Supervisor	When you log on as a User
Press the power button with the USER button pressed. <ul style="list-style-type: none"><li>If you do not do so, even when you set enter the Supervisor Password, the wireless display will run in the User operating environment.</li></ul>	Press the power button.





### 2 When the [Enter Password] screen appears, enter the password, and then tap [OK].

- When you log on as a User  
When the check mark is added for [Skip Password Dialog] of the [User] tab in [Security (Supervisor)], the [Enter Password] screen is not displayed. (→ page 26)



# Starting Up/Shutting Down

## 3 Connect to the server.

When making connections with Microsoft® Remote Desktop Connection	When making connections with Citrix® ICA® Client
<p>Double-tap  *1 on the desktop.</p> <p>The server desktop screen will appear.</p> <p>*1 The file name entered when making the server setting will appear instead of "XXX".</p> <ul style="list-style-type: none"> <li>When you do not add the check mark for [Save my password] in "When making connections with Microsoft® Remote Desktop Connection" step ③ of "First-time Operation" step 7(➔ page 22): Enter the password, and then tap [OK].</li> </ul>	<p>Double-tap  *2 the desktop.</p> <p>*2 The file name entered when making the server setting will appear instead of "XXX".</p>
When making connections with Microsoft® Internet Explorer	
<p>Double-tap  on the desktop.</p>	

### NOTE

- When logged on as a User, the security setting screen can be displayed using the following procedure.



① Double-tap  on the desktop.

② Double-tap [Security (User)].  
The following screen will appear.



A. Auto Launch (➔ page 25)

B. Wait for Network Connection (➔ page 25)

- When the Supervisor does not add the check mark for [Allow Change Auto Launch] in the [User] tab of the [Security Settings (Supervisor)] screen, [Auto Launch] and [Wait for Network Connection] cannot be set here.

C. Password

To set the password: ➔ page 24

- If a User Password has been set in the [User] tab of [Security (Supervisor)] screen, User cannot delete a password.
- If a User Password has not been set in the [User] tab of [Security (Supervisor)] screen, User cannot create a new password.

## ■ When terminating the connection

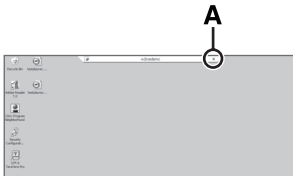

Perform the following operation.

- Tap [Start] - [Log Off] - [Log Off].



<Only when making connections with Microsoft® Remote Desktop Connection>

You can terminate the connection using the following operation.

- Tap  (A), and when the message appears, tap .

### CAUTION

- If you tap [Start] - [Shut Down], the power for the server itself will be turned off.

## Make the settings (only for the Supervisor)

### ■ When settings have been changed

Before turning off the wireless display, save (back up) the settings making reference to step 9 in “First-time Operation” (→ page 27).

### ■ When deleting settings

Perform the following procedure.



- ① Double-tap  on the desktop and double-tap [Flash Delete].

- ② Connect your wireless display to a power outlet. (→ page 19)

- ③ Tap [Delete Backup].

When the confirmation message appears, tap [Yes].

Deleting data will start.

- ④ When the message “Backup data has been deleted.” appears, tap .

### NOTE

- When you turn on the wireless display next time, the calibration screen will appear. (→ page 20)

### ■ When returning the wireless display to its condition at the time of shipment

Perform the following procedure while the wireless display is turned off.

- ① Connect your wireless display to a power outlet. (→ page 19)

# Starting Up/Shutting Down

- ② Press the power button with the keyboard button and USER button (→ page 38) pressed until the message “Reset the device to factory default...” appears.
  - When the [Enter Password] screen appears, enter the Supervisor Password and tap [OK].
- ③ Select [Yes].

---

## NOTE

- When you turn on the wireless display next time, the calibration screen will appear. (→ page 20)
- 

## Shutting Down (power off the wireless display)

- 1 **Press the power button for one or two seconds until the message “Preparing to Power off...” appears.**
  - When shutting down forcefully, press the power button for four seconds or longer.



# LCD (Touchscreen)

## Using the Stylus

---

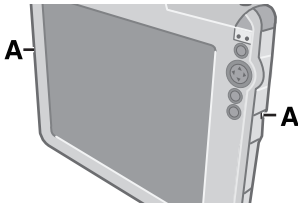

Use the stylus provided to perform operations on the touchscreen. The stylus is located in the stylus holder (A), and can be held like a pen or pencil. The following operations are possible on the touchscreen.

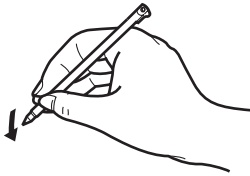

### Tapping

You can select an item on the screen by tapping it with the stylus. This operation is called a “tap”.



### Dragging

You can drag an item on the screen by holding the stylus down over the item and then moving the stylus. This operation is called a “drag”.

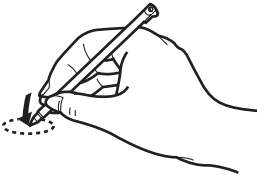

### Tapping and Holding

You can tap and hold the stylus on an item to see a list of actions available for that item. On the pop-up menu that appears, tap the action you want to perform.

### Right-clicking

You can execute the right click operation. (→ page 38)

## Handling the Stylus

---

- Clean the stylus tip and screen prior to operation. Foreign particles can scratch the screen and impede the operation of the stylus.
- Use the provided stylus only on the screen. Using it for any other purpose may damage the stylus and scratch the screen.

# LCD (Touchscreen)

## Handling the Touchscreen

---

- Use the provided stylus with CF-08. Do not use an implement other than the stylus that comes with the wireless display.
- Do not place any object on the surface or press down forcefully with sharp-pointed objects (e.g., nails), or hard objects that can leave marks (e.g., pencils and ball point pens).
- Do not operate the wireless display when such things as dust are on the LCD. Do not allow substances such as oil to contact the LCD. The cursor may not work properly in such cases.

## Aligning the touchscreen

---

Align the touchscreen if the cursor does not correctly move to the position where the stylus touches the touchscreen of the wireless display.



- ① Double-tap **Control Panel** on the desktop, and double-tap [Stylus].
- ② Tap the [Calibration] tab, and tap [Recalibrate].

## Rotating the screen

---

To rotate the screen, perform the following procedure.





- ① Double-tap **Control Panel** on the desktop.
- ② Double-tap [Rotate].
- ③ Add the check mark for [0 degrees (Landscape)], [90 degrees], [180 degrees] or [270 degrees], and tap [Rotate].  
The screen will rotate to the position selected.

Using the following procedure, you can set the screen to rotate to a preset position with the press of a single button.

- Here, we will explain how to make the following settings:
  - Button to be used/push length: keyboard button/long push
  - Setting angles: [0 degrees (Landscape)] and [90 degrees]



Control  
Panel

- ① Double-tap  on the desktop.
  - ② Double-tap [Buttons].
  - ③ Assign [Rotate Screen] to the keyboard button, long push, and tap .
  - ④ Double-tap [Rotate].
  - ⑤ Add the check mark for [0 degrees (Landscape)] and [90 degrees], and tap .
  - ⑥ Save the above setting.  
Refer to step **9** of “First-time Operation” (→ page 27).
  - ⑦ Press the keyboard button for more than 2 seconds.  
The screen will rotate to [90 degrees].  
If you press the keyboard button once more, the screen will return to [0 degrees (Landscape)].
- You can set the screen to rotate to a preset position using Quick Menu, just like the button setting above. (→ page 39)

# Battery Power

## Battery Indicator

Battery indicator	Battery status
Not lit	The battery pack is not inserted or not being charged.
Pulsing orange	Charging is in progress.
Green	The battery is fully-charged.
Red	The remaining battery is approximately 9% or less.
Blinking red	The battery pack or the charging circuit is not operating normally.
Blinking orange	The battery cannot be charged temporarily due to the following reason: <ul style="list-style-type: none"><li>● Its internal temperature is out of the acceptable range.</li></ul>

### NOTE

- Once the battery is fully charged, the wireless display performs recharging only when the battery level becomes less than approximately 95%, so overcharging is avoided.

## Checking the Remaining Battery Charge

You can check the remaining battery charge using any of the following methods.

- Double-tap  on the desktop, double-tap [Power] and tap the [Battery] tab.
- Press the keyboard button or USER button (→ page 38) and run Quick Menu (→ page 39).

You can reduce power consumption using the following method.  
When using the battery, the wireless display can be used for a longer period of time.  
Power conservation effects can be achieved even when the AC adaptor is connected.

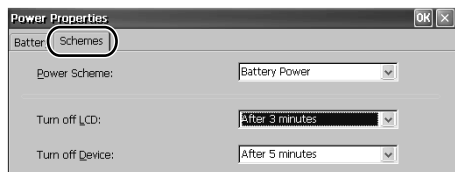

- Double-tap  on the desktop, double-tap [Power] and tap the [Schemes] tab.

Power consumption can also be minimized with detailed settings; for example, by reducing the time setting for [Turn off LCD].



## Replacing the Battery Pack

The battery pack is a consumable item so the replacement (CF-VZSU44U) will be necessary. If the battery operation time becomes noticeably short, replace with a new battery.

How to remove/insert the battery pack: → page 17

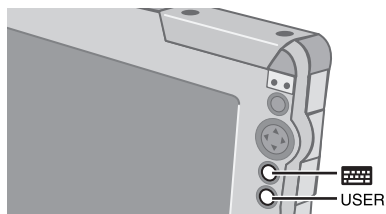
# Buttons



You can display screens for frequently used functions and applications by pressing the keyboard button  or USER button  on this wireless display.

Two functions can be assigned to each button; one that starts up with a short push (less than 2 seconds) and one that starts up with a long push (more than 2 seconds).

At the time of purchase, the following functions or applications are assigned to each button.

Keyboard button	Short push	Input Panel (→ page 41)
	Long push	Input Panel Selector (→ page 42)
USER button	Short push	Quick Menu (→ page 39)
	Long push	Right Click* <sup>1</sup>

\*<sup>1</sup> To execute the right click operation:



① Press the USER button for more than 2 seconds.

You can use the right click once.

Each time after this, before using the right click once, execute step ① above.

You can also execute the right click operation using Quick Menu (→ page 39).

## Customizing buttons

- ① Double-tap  on the desktop and then double-tap [Buttons].
- ② When the [Buttons] screen appears, tap , and then select the function name in accordance with the button positions and short/long push that you want to set.
- ③ Tap .
- ④ Save the above setting.  
Refer to step 9 of “First-time Operation” (→ page 27).

# Quick Menu

Quick Menu is used to display information about the wireless display, or to enable frequently used functions and applications to be launched quickly without going through Control Panel (→ page 53).

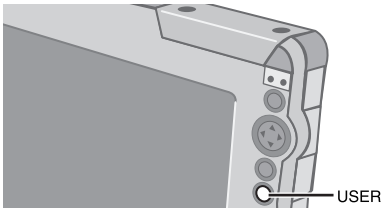

At the time of purchase, Quick Menu can be launched with a short push of the USER button

USER .

How to change Quick Menu launching method:  
→ page 38

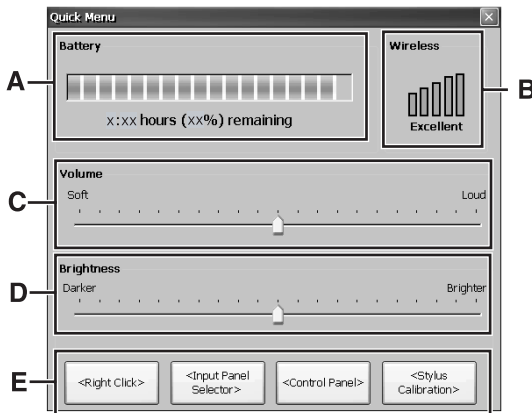

## A. Battery

Display remaining battery level  
(Same setting for [Power] in Control Panel).

## B. Wireless

Display status of wireless LAN.

## C. Volume

Set and change sound volumes  
(Same setting for [Volume & Sounds] in Control Panel).

## D. Brightness

Set and change display backlight brightness (Same setting for [Backlight] in Control Panel).

## E. Buttons

Start up frequently used functions and applications.

At the time of purchase, [Right Click]<sup>\*1</sup>, [Input Panel Selector] (→ page 42), [Control Panel] (→ page 53) and [Stylus Calibration] are set in Quick Menu.

\*1 To execute the right click operation:

① Tap [Right Click].

You can use the right click once.

Each time after this, before using the right click once, execute step ① above.

You can also execute the right click operation by pressing the keyboard button or USER button. (→ page 38)



# Quick Menu

## Customizing buttons

---

- ① Double-tap  on the desktop and then double-tap [Quick Menu].  
Control  
Panel

The [QuickMenu Application Assignment] screen will appear.

- ② In [1. Select Button], tap one button to which the function or application is to be assigned from among the four buttons.
- ③ In [2. Assign a Function], tap , and then select the function or application to be assigned.
- ④ Tap .
- ⑤ Save the above setting.  
Refer to step **9** of “First-time Operation” (→ page 27).



# Software Keyboard

The Software Keyboard can be displayed on the wireless display, and you can then input characters or symbols by tapping the Software Keyboard.

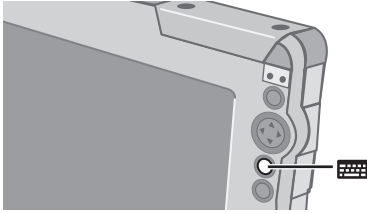

To show or hide the Software Keyboard (input panel) (at the time of purchase):

- Press the keyboard button  for less than 2 seconds.

## ■ Input methods

Numeric Keyboard, Full Keyboard and Transcriber can be used.

Numeric Keyboard and Full Keyboard can be selected as either large or small panels.

- To use Transcriber, refer to “Transcriber” (➔ page 42).

## Full Keyboard / Numeric Keyboard



Full keyboard

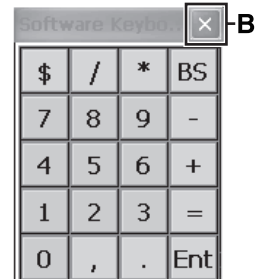

Numeric keyboard

**A. The keyboard will move to the four corners of the screen.**

**B. Close the keyboard.**

## ■ To change the input method (and/or panel size):

At the time of purchase, this wireless display is set to display the Full keyboard (small).

You can change the setting using any of the following methods.

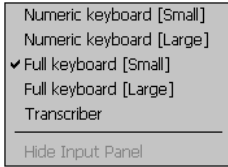

- Display Input Panel Selector screen, and then add the check mark to the input method to be changed.

# Software Keyboard



Input Panel Selector

(At the time of purchase, this wireless display is set to display the Input Panel Selector Screen using the following method.)

- Press the keyboard button for more than 2 seconds. (→ page 38)
  - Press the USER button for less than 2 seconds to launch Quick Menu (→ page 39), and then tap [Input Panel selector].
- Display the [Keyboard Options] screen and select the input method in the following procedure.
    - ① Double-tap [Input Panel] in [Control Panel].
    - ② In the [Input Panel Properties] screen, select [Keyboard] (A), and then tap [Options] (B).
    - ③ In the [Keyboard Options] screen, change the input method (and/or panel size), and then tap .
    - ④ Tap .

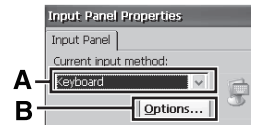

## Transcriber

Transcriber is a function that enables you to input letters, characters or symbols by writing directly on the touchscreen using the stylus.

- If the [Transcriber intro] screen is displayed before Transcriber is displayed, tap  to close the screen.
- Transcriber cannot be used if the wireless display is connected to a server using the Microsoft® Remote Desktop Connection.

### ■ To change the input method to Transcriber:

At the time of purchase, this wireless display is set to display the Full keyboard (small). You can change the setting using any of the following methods.

- Display Input Panel Selector screen (→ above), and then add the check mark for [Transcriber].
- Double-tap [Input Panel] in [Control Panel], select [Transcriber] and tap .

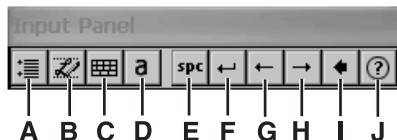

### A. Option settings

Display the [Transcriber: Options] screen of Transcriber option settings. (→ below)

### B. Change recognition mode

Run hand/block letter (character (alphabet/symbol/numeric)).

### C. Display symbol input panel

Display the screen for symbol input.

### D. Change upper/lower/symbol mode

Change input mode to upper/lower/symbol mode.

### E. Space

Input space.

### F. Line feed

Insert line feed.

### G. Left move

Move cursor to left.

### H. Right move

Move cursor to right.

### I. BS

Backspace (delete one character).

### J. Help

Display help screen.

## Option settings

The following settings can be made by tapping each tab.

### ■ [Quick Settings] tab

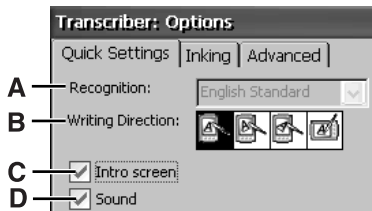

### A. Recognition

Change the language of the recognition engine. (In this wireless display, [English Standard] is set and it cannot be changed.)

### B. Writing Direction

Change the handwriting input direction.

### C. Intro screen

If the check mark is added, the Help screen will be displayed when the Transcriber starts up.

### D. Sound

If the check mark is added, you will hear a sound when the Transcriber starts up. The volume of this sound will be the same as the volume set in Quick Menu (→ page 39) or in [Volume & Sounds] in Control Panel.

# Software Keyboard

## ■ [Inking] tab

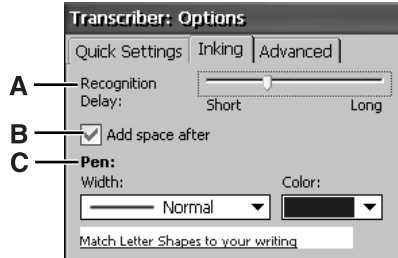

### A. Recognition Delay

Slide the bar to set the time for recognition of handwritten characters.

### B. Add space after

If the check mark is added, when handwritten characters are recog-

nized and displayed on the screen, a single space will also be displayed at the end of each character.

### C. Pen

Tap to set the width and color of the ink.

## ■ [Advanced] tab

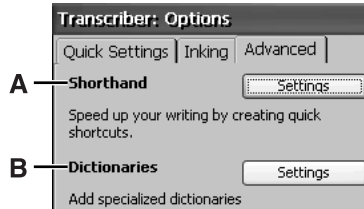

### A. Shorthand

Register shorthand. For further information, refer to “Shorthand” (→ page 45).

### B. Dictionaries

Select a dictionary.

## ■ Shorthand

The following functions can be assigned for handwriting input.

Text expansion	Function	Run program
Display words, phrases, or sentences.	Display dates, names, or other information.	Start up a program.
e.g.: Input “ABC” in handwriting to display “Hello.”	e.g.: Input “DEF” in handwriting to display the date and time.	e.g.: Input “GHI” in handwriting to start up [Command Prompt].

① Tap [Settings] to the right of “Shorthand.”



② Tap [Add].



③ Select the function that you want to assign, and then tap [Next].





④ Register shorthand.

Text expansion	Function	Run program
Input “ABC” in handwriting on the screen.	Input “DEF” in handwriting on the screen.	Input “GHI” in handwriting on the screen.
The handwriting input will be displayed in the [Shorthand] box.		



⑤ Register a function.

Text expansion	Function	Run program
Tap the [Text expansion] box, and then input “Hello” in handwriting on the screen. “Hello” will be displayed in the [Text expansion] box.	Tap  in the [Function] box, and a list will appear; select [date and time].	Tap  in the [Run program] box, and a list will appear; select [Command Prompt].



# Software Keyboard

- ⑥ Tap [Finish].  
The screen will automatically return to step ②.  
To assign two or more functions in succession, repeat step ② to ⑥.



- ⑦ Tap .



- ⑧ Tap  to close the [Transcriber: Options] screen.





- ⑨ Save the above setting.  
Refer to step 9 of “First-time Operation” (→ page 27).

# Signature Capture

Signature Capture operates on CF-08, supporting input of signatures in applications running on the connection destination server.

At the time of purchase, this wireless display is not preset to enable startup of Signature Capture. Before using Signature Capture, set the wireless display to enable startup using one of the following methods.

<p>When launching with the keyboard button or USER button</p>	<p>When launching with Quick Menu</p> <ul style="list-style-type: none"> <li>At the time of purchase, this wireless display is set so that Quick Menu can be started up with a short push of the USER button.</li> </ul>
<p>① Double-tap  on the desktop.</p>	
<p>② Double-tap [Buttons].</p>	<p>② Double-tap [Quick Menu].</p>
<p>③ Select [Signature Capture] from among the buttons to be used (keyboard button or USER button), set the push length (short push or long push), and tap .</p>	<p>③ Select a button, select [Signature Capture] from [Assign a Function], and then tap .</p>
<p>④ Save the above setting. Refer to step <b>9</b> of “First-time Operation” (→ page 27).</p>	

## ■ To use Signature Capture:

- ① Launch Signature Capture with the keyboard button, USER button or Quick Menu.
- ② Tap , and then tap [Setting].  
You can set the pen width and image size.
- ③ Write a character or symbol, and tap [Capture].  
The image input by handwriting will be copied onto the server, and Signature Capture will close.

## ■ To view the handwritten image:

- Check to make sure that the server is set to enable Signature Capture data to be pasted.
  - ① Connect to the server. (→ page 30)
  - ② Tap [Start] - [Run].
  - ③ Input [clipbrd.exe] and then tap [OK].  
The [ClipBook viewer] screen will appear.

# SD Memory Card

## About SD Memory Card

---

An SD Memory Card can be used for the following purposes.

- The exchange of data with various devices equipped with an SD Memory Card slot, and so on.
- Use as a memory card (e.g., use as a storage unit on which files can be written).

## Inserting/Removing a Card

---

- 1 **Open the SD Memory Card slot cover and confirm the SD Memory Card indicator  is off.**

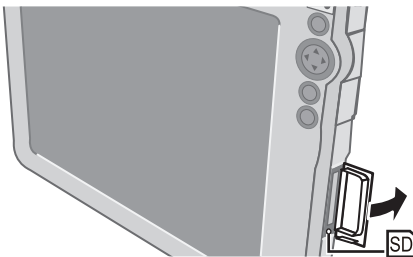

- 2 **Insert/Remove a Card.**

■ **To insert the card**

Insert the SD Memory Card until it snaps into place as shown in the illustration.

■ **To remove the card**

- ① Press the card so it comes out of the slot.
- ② Draw it straight out.

To insert the card

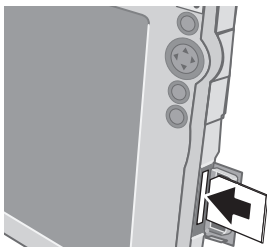

To remove the card

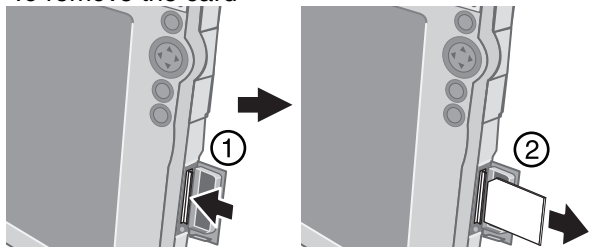

- 3 **Close the SD card slot cover.**



# Bluetooth

## To enable Bluetooth

- 1 Double-tap  on the desktop.
- 2 Double-tap [Bluetooth Device Properties].
- 3 Tap the [General] tab, and make the necessary settings.

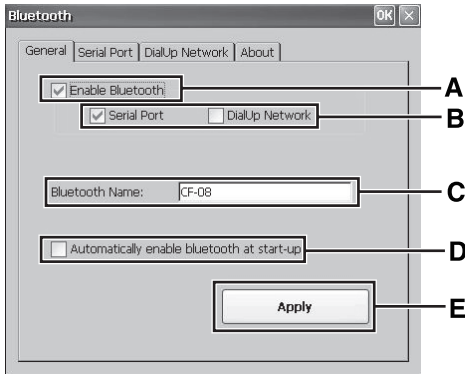

- A. Enable Bluetooth  
Add the check mark for [Enable Bluetooth] to enable Bluetooth.
  - B. Serial Port / DialUp Network  
Add the check mark for [Serial Port] or [DialUp Network] to make connections with the serial port or dial-up Network.
  - C. Bluetooth Name  
Set the device name for Bluetooth.
  - D. Automatically enable bluetooth at start-up  
When you add the check mark for [Automatically enable bluetooth at start-up], Bluetooth will be enabled when the system is started up.
  - E. Apply  
(→ below)
- 4 Tap [Apply] (E) to reflect the settings.  
To make connections with the serial port: → page 50  
To make connections with the dial-up network: → page 51

# Bluetooth

## ■ To make connections with the serial port

Tap the [Serial Port] tab, and make the following procedure.

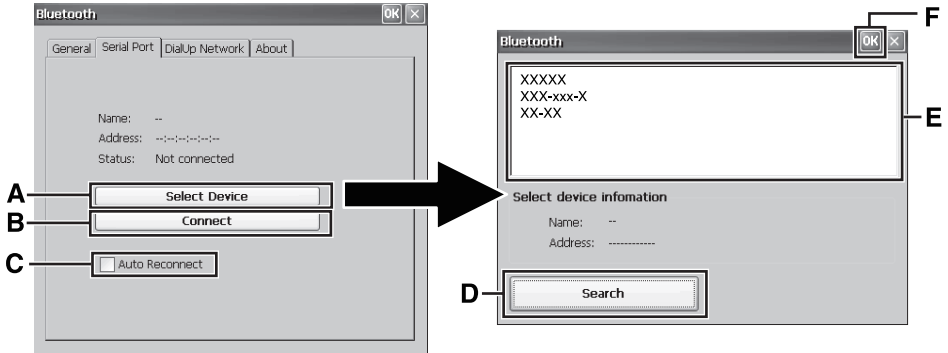

- ① Turn on the Bluetooth device.
- ② Tap [Select Device] (A).
  - If you add the check mark for [Auto Reconnect] (C), the connection will be made automatically when Bluetooth is enabled.
- ③ Tap [Search] (D).
- ④ Tap the Bluetooth device name you want to connect from the list box (E).
- ⑤ Tap **OK** (F).
- ⑥ Tap [Connect] (B).

When the [Enter PIN code] screen appears, enter the pin code, and then tap [OK].

When the connection is active, the [Status] display shows “Connected.”

  - To terminate the connection  
Tap [Disconnect] from the [Serial Port] tab.  
When the connection is broken, the [Status] display shows “Not connected.”

## ■ To make connections with the dial-up network

Tap the [DialUp Network] tab, and make the following procedure.

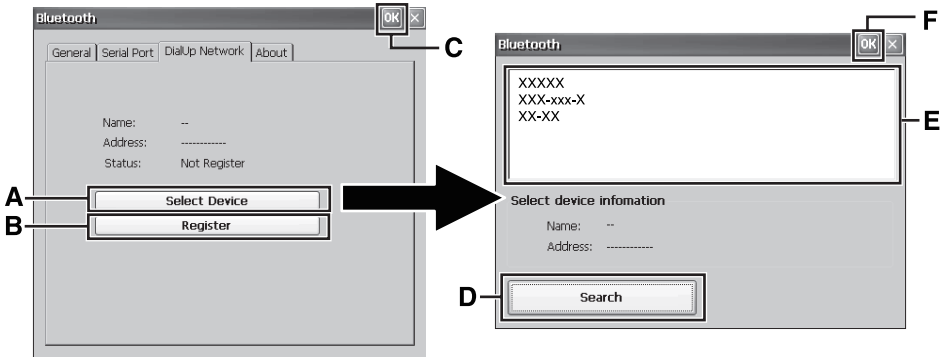

- The setting procedure below may vary depending on the Bluetooth device you are using. (For example, the [Enter PIN code] screen described in step ⑥ may appear multiple times or in a different order.)

For details, refer to the manual that comes with your Bluetooth device.

① Turn on the Bluetooth device.

② Tap [Select Device] (A).

③ Tap [Search] (D).

④ Tap the Bluetooth device name you want to connect from the list box (E).

⑤ Tap **OK** (F).

⑥ Tap [Register] (B).

When the [Enter PIN code] screen appears, enter the pin code, and then tap



⑦ Tap **OK** (C).

⑧ Double-tap [Network and Dial-up Connections] in [Control Panel].

⑨ Double-tap [Make New Connection].

⑩ At the [Make New Connection] screen, tap [Next].

To change the connection name, enter a name in the [Type a name for the connection:] text field, and then tap [Next].

⑪ At the [Modem] screen, select [Bluetooth Modem on COM7], and then tap [Next].

⑫ At the [Phone Number] screen, enter the phone number, and tap [Finish].

⑬ Double-tap [Network and Dial-up Connections] in [Control Panel].

# Bluetooth

- ⑭ Double-tap the connection name created in step ⑩.
- ⑮ At the [Dial-Up Connection] screen, enter the proper User Name, Password, and Domain (G) for the connection destination.

If the phone number entered in step ⑫ does not display correctly at “Phone” (H), such as too many numbers showing, perform the following operation.

Tap [Dial Properties] (I).



Tap [Dialing Patterns], enter the correct number, and then tap .

↓

Tap .

- ⑯ Tap [Connect].

When the connection is active, the [My Connection Status] screen shows “Connected.”

- To save the above setting, refer to step 9 of “First-time Operation” (→ page 27).
- To terminate the connection, tap [Disconnect].

# Control Panel

In Control Panel, you can see the list of applets that can be used on this wireless display. If you double-tap the icon (or the name), the screen will start up. Explanations for each Control Panel applet can be displayed using the following procedure.

- ① Double-tap  on the desktop.  
Control  
Panel
- ② Tap [View].
- ③ Tap [Details].

---

**CAUTION**

- After changing settings, if you do not tap , some settings will not take effect.
-

# For Effective Use

---

## Maintenance

---

### ■ LCD

Do not use water when cleaning the panel. Ingredients included in water may leave residue and reduce readability of the screen.

<When cleaning dust/dirt>

Avoid rubbing off dust/dirt with cloth since it may leave scratch on the screen.

Sweep dust/dirt with fine brush, then wipe it with "dry" soft cloth used for cleaning glasses.

<When cleaning oily surface>

Apply camera lens cleaner on a soft gauze and clean it with gentle force. Then, wipe with dry soft cloth used for cleaning glasses.

### ■ Areas excluding the LCD

Wipe these areas with a soft cloth, after applying water or detergent diluted with water to the soft cloth and firmly wringing out excess water.

---

#### CAUTION

- Do not use benzene, thinner, or rubbing alcohol. Doing so may adversely affect the surface, e.g., discoloration. In addition, do not use commercially-available household cleaners and cosmetics, as they may contain components harmful to the surface.
  - Do not directly add or spray water or detergent. If liquid enters the inside of the wireless display, it may cause the wireless display to work improperly or be damaged.
-

# Troubleshooting

Follow the instructions below when a problem has occurred. For a software problem, refer to the software's instruction manual. If the problem persists, contact your technical support office.

## ■ Starting Up

Cannot start up. The power indicator or battery indicator is not lit.	<ul style="list-style-type: none"><li>● Connect the AC adaptor.</li><li>● Insert a fully charged battery.</li><li>● Remove the battery pack and the AC adaptor, then connect them again.</li></ul>
Cannot turn on the wireless display.	<ul style="list-style-type: none"><li>● Leave it in an environment of 5 °C {41 °F} or higher temperature for about an hour, then turn on the power once more.</li></ul>
You have forgotten the password.	<ul style="list-style-type: none"><li>● Supervisor Password or User Password: Contact your technical support office.</li></ul>
The date and time are incorrect.	<ul style="list-style-type: none"><li>● Make the correct settings. Double-tap  on the desktop, and double-tap [Date/Time].</li></ul>
Other startup problems.	<ul style="list-style-type: none"><li>● Remove all peripheral devices.</li></ul>

## ■ Display

No display.	<ul style="list-style-type: none"><li>● The display is turned off by the power-saving function. To resume, touch the LCD.</li><li>● The wireless display powers off by the power-saving function. To power on, press the power button.</li></ul>
The screen is dark.	<ul style="list-style-type: none"><li>● Adjust the brightness. As you increase the brightness, battery consumption increases.</li></ul>

## ■ Touchscreen

The cursor does not work.	<ul style="list-style-type: none"><li>● When using the external mouse, connect it correctly.</li></ul>
Cannot point the correct position using the included stylus.	<ul style="list-style-type: none"><li>● Perform the touchscreen calibration (→ page 34).</li></ul>

# Troubleshooting

## ■ Shut Down

Cannot shut down.	<ul style="list-style-type: none"><li>● Press the power button for four seconds or longer to shut down the wireless display.</li></ul>
-------------------	--

## ■ Sound

No sound.	<ul style="list-style-type: none"><li>● Confirm the volume for [Quick Menu] or [Volume &amp; Sounds] in Control Panel.</li></ul>
Unable to hear sound in stereo.	<ul style="list-style-type: none"><li>● Playback conditions vary depending on the server.<ul style="list-style-type: none"><li>• If you are connecting through Microsoft® Remote Desktop Connection or a web server, you will hear monaural sound even if the original sound is stereo.</li><li>• For playback conditions when connecting through Citrix® Presentation Server 4.0, refer to the Citrix manual for details.</li></ul></li></ul>

## ■ Wireless Communication

Cannot connect to network.	<ul style="list-style-type: none"><li>● Check the network settings.</li><li>● You may experience interference with other wireless LAN access points. Verify that each wireless LAN access point is set to a different channel.</li></ul>
----------------------------	--

## ■ Connecting Peripherals

The connected keyboard and mouse do not work.	<ul style="list-style-type: none"><li>● Check the keyboard and mouse connection.</li></ul>
The device connected to the serial port does not work.	<ul style="list-style-type: none"><li>● Check the connection.</li><li>● The device driver may not work. Refer to the instruction manual of the device.</li><li>● Do not connect two mouse devices simultaneously.</li></ul>
Cannot print.	<ul style="list-style-type: none"><li>● Check the printer connection.</li><li>● Turn on the printer.</li><li>● The printer is not online.</li><li>● No paper is in the printer tray or there is a paper jam.</li><li>● Turn on the printer and connect it to the wireless display, and then turn on the wireless display.</li></ul>



## ■ Others

No response.

- The screen content may not display correctly due to poor signal quality. In such case, move to a place where signal quality is good then make a connection.
- Press the power button for four seconds or longer to shut down the wireless display, and then press the power button to turn it on.

# LIMITED USE LICENSE AGREEMENT

THE SOFTWARE PROGRAM(S) (“PROGRAMS”) FURNISHED WITH THIS PANASONIC® PRODUCT (“PRODUCT”) ARE LICENSED ONLY TO THE END-USER (“YOU”), AND MAY BE USED BY YOU ONLY IN ACCORDANCE WITH THE LICENSE TERMS DESCRIBED BELOW. YOUR USE OF THE PROGRAMS SHALL BE CONCLUSIVELY DEEMED TO CONSTITUTE YOUR ACCEPTANCE OF THE TERMS OF THIS LICENSE.

Matsushita Electric Industrial Co., Ltd. (“MEI”) has developed or otherwise obtained the Programs and hereby licenses their use to you. You assume sole responsibility for the selection of the Product (including the associated Programs) to achieve your intended results, and for the installation, use and results obtained therefrom.

## LICENSE

- A. MEI hereby grants you a personal, non-transferable and non-exclusive right and license to use the Programs in accordance with the terms and conditions stated in this Agreement. You acknowledge that you are receiving only a LIMITED LICENSE TO USE the Programs and related documentation and that you shall obtain no title, ownership nor any other rights in or to the Programs and related documentation nor in or to the algorithms, concepts, designs and ideas represented by or incorporated in the Programs and related documentation, all of which title, ownership and rights shall remain with MEI or its suppliers.
- B. You may use the Programs only on the single Product which was accompanied by the Programs.
- C. You and your employees and agents are required to protect the confidentiality of the Programs. You may not distribute or otherwise make the Programs or related documentation available to any third party, by time-sharing or otherwise, without the prior written consent of MEI.
- D. You may not copy or reproduce, or permit to be copied or reproduced, the Programs or related documentation for any purpose, except that you may make one (1) copy of the Programs for backup purposes only in support of your use of the Programs on the single Product which was accompanied by the Programs. You shall not modify, or attempt to modify, the Programs.
- E. You may transfer the Programs and license them to another party only in connection with your transfer of the single Product which was accompanied by the Programs to such other party. At the time of such a transfer, you must also transfer all copies, whether in printed or machine readable form, of every Program, and the related documentation, to the same party or destroy any such copies not so transferred.

F. You may not remove any copyright, trademark or other notice or product identification from the Programs and you must reproduce and include any such notice or product identification on any copy of any Program.

YOU MAY NOT REVERSE ASSEMBLE, REVERSE COMPILE, OR MECHANICALLY OR ELECTRONICALLY TRACE THE PROGRAMS, OR ANY COPY THEREOF, IN WHOLE OR IN PART.

YOU MAY NOT USE, COPY, MODIFY, ALTER, OR TRANSFER THE PROGRAMS OR ANY COPY THEREOF, IN WHOLE OR IN PART, EXCEPT AS EXPRESSLY PROVIDED IN THE LICENSE.

IF YOU TRANSFER POSSESSION OF ANY COPY OF ANY PROGRAM TO ANOTHER PARTY, EXCEPT AS PERMITTED IN PARAGRAPH E ABOVE, YOUR LICENSE IS AUTOMATICALLY TERMINATED.

#### **TERM**

This license is effective only for so long as you own or lease the Product, unless earlier terminated. You may terminate this license at any time by destroying, at your expense, the Programs and related documentation together with all copies thereof in any form. This license will also terminate effective immediately upon occurrence of the conditions thereof set forth elsewhere in this Agreement, or if you fail to comply with any term or condition contained herein. Upon any such termination, you agree to destroy, at your expense, the Programs and related documentation together with all copies thereof in any form.

YOU ACKNOWLEDGE THAT YOU HAVE READ THIS AGREEMENT, UNDERSTAND IT AND AGREE TO BE BOUND BY ITS TERMS AND CONDITIONS. YOU FURTHER AGREE THAT IT IS THE COMPLETE AND EXCLUSIVE STATEMENT OF THE AGREEMENT BETWEEN US, WHICH SUPERSEDES ANY PROPOSAL OR PRIOR AGREEMENT, ORAL OR WRITTEN, AND ANY OTHER COMMUNICATIONS BETWEEN US, RELATING TO THE SUBJECT MATTER OF THIS AGREEMENT.

# Contrat de licence d'usage limité

Le(s) logiciel(s) (les "Logiciels") fournis avec ce produit Panasonic® (le "Produit") sont exclusivement concédés en licence à l'utilisateur ultime ("vous"), et ils ne peuvent être utilisés que conformément aux clauses contractuelles cidessous. En utilisant les logiciels, vous vous engagez de manière définitive à respecter les termes, clauses et conditions des présentes.

Matsushita Electric Industrial Co., Ltd. ("MEI") a mis au point ou obtenu les Logiciels et vous en concède l'utilisation par les présentes. Vous assumez l'entière responsabilité du choix de ce Produit (y compris des Logiciels associés) pour obtenir les résultats escomptés, ainsi que de l'installation, de l'utilisation et des résultats obtenus.

## Licence

- A. MEI vous octroie par les présentes le droit et la licence personnels, non cessibles et non exclusifs d'utiliser les Logiciels conformément aux termes, clauses et conditions de ce contrat. Vous reconnaissez ne recevoir qu'un droit limité d'utiliser les Logiciels et la documentation les accompagnant et vous vous engagez à n'obtenir aucun droit de titre, propriété ni aucun autre droit vis-à-vis des Logiciels et de la documentation les accompagnant ni vis-à-vis des algorithmes, concepts, dessins, configurations et idées représentés par ou incorporés dans les Logiciels et la documentation les accompagnant, dont les titres, la propriété et les droits resteront tous à MEI ou à leurs propriétaires.
- B. Vous ne pouvez utiliser les Logiciels que sur le Produit unique qui est accompagné par les Logiciels.
- C. Vous et vos employés ou agents êtes requis de protéger la confidentialité des Logiciels. Vous ne pouvez ni distribuer ni mettre les Logiciels et la documentation les accompagnant à la disposition d'un tiers, par partage de temps ou de quelque autre manière que ce soit, sans l'autorisation écrite préalable de MEI.
- D. Vous ne pouvez ni copier ni reproduire ni permettre la copie ni la reproduction des Logiciels ni de la documentation les accompagnant pour quelque fin que ce soit, à l'exception d'une (1) copie des Logiciels à des fins de sauvegarde uniquement pour soutenir votre utilisation des Logiciels sur le Produit unique qui est accompagné par les Logiciels. Vous ne pouvez ni modifier ni tenter de modifier les Logiciels.
- E. Vous ne pouvez céder les Logiciels et en octroyer la licence à une autre partie qu'en rapport avec votre cession du Produit unique qui est accompagné par les Logiciels à cette autre partie. Au moment de cette cession, vous devez céder également toutes les copies, que ce soit sous forme imprimée ou lisible par la

machine, de tous les Logiciels ainsi que de la documentation les accompagnant, à la même partie ou détruire les copies non cédées.

- F. Vous ne pouvez retirer aucune marque de droits d'auteur, marque de commerce ou autre ni aucune identification de produit des Logiciels et vous devez reproduire et inclure toutes ces notices ou identifications de produit sur toutes les copies des Logiciels.

Vous ne pouvez assembler en sens inverse, compiler en sens inverse ni retracer les Logiciels ni aucune de leurs copies, de façon électronique ou mécanique, en tout ou en partie.

Vous ne pouvez utiliser, copier, modifier, altérer ni céder les Logiciels ni aucune de leurs copies, en tout ou en partie, à l'exception de ce qui est expressément stipulé dans ce contrat.

Si vous cédez la possession de toute copie ou de tout Logiciel à une autre partie, à l'exception de ce qui est autorisé au paragraphe E ci-dessus, votre licence est automatiquement résiliée.

### **Termes, clauses et conditions**

Cette licence n'est effective que pour la durée de possession ou de crédit-bail du Produit, à moins d'une résiliation antérieure. Vous pouvez résilier cette licence à tout moment en détruisant, à vos frais, les Logiciels et la documentation les accompagnant avec toutes leurs copies, sous quelque forme que ce soit. Cette licence sera également résiliée, avec application immédiate, si les conditions de résiliation définies ailleurs dans ce contrat se sont réalisées ou si vous ne respectez pas les termes, clauses et conditions qui y sont contenues. Au moment de la résiliation, vous acceptez de détruire, à vos frais, les Logiciels et la documentation les accompagnant avec toutes leurs copies, sous quelque forme que ce soit.

Vous reconnaissez avoir lu ce contrat, en avoir compris toute la substance et avoir accepté de respecter ses termes, clauses et conditions. Vous reconnaissez en outre qu'ils sont la description complète et exclusive du contrat conclu entre nous, contrat qui remplace et annule toute proposition ou contrat précédent, écrit ou oral, et toute autre communication entre nous, relativement à l'objet du présent contrat.

# Specifications

## ■ Main Specifications

Model No.	CF-08TX1A1M	
CPU	Intel® PXA270 Processor 312 MHz	
Memory (ROM/RAM)	32 MB (Flash) /64 MB	
Display Method	10.4 XGA type	
	Internal LCD Display	65,536 colors (1024 × 768 pixels)
Wireless LAN	Built-in (→ page 63)	
Bluetooth	Built-in (→ page 63)	
LAN	IEEE 802.3 10Base-T, IEEE 802.3u 100Base-TX	
Sound	WAVE playback, Monaural speaker	
Card Slot	SD Memory Card*1	× 1, Data transfer rate=4.8 MB per second*2
Interface	USB Port × 1 (USB1.1), LAN Port (RJ-45), Expansion Bus Connector (Dedicated 16-pin), Microphone Jack (Miniature jack, 3.5 DIA, Monaural), Headphone Jack (Miniature jack, 3.5 DIA, Impedance 32Ω, Output Power 4 mW × 2)	
Button	Power button, USER button, Keyboard button, Cursor control button (with Enter key)	
Pointing Device	Touchscreen (Anti-Reflection, Stylus (included) touch capable)	
Power Supply	AC adaptor or Battery pack	
AC Adaptor*3	Input: 100 V to 240 V AC, 50 Hz/60 Hz Output: 16.0 V DC, 2.5 A	
Battery Pack	Li-ion 7.4 V, 5.2 Ah	
	Operating Time*4	Approx. 4.5 hours to 14 hours*5 (Approx. 7 hours)*6
	Charging Time*4	Approx. 4 hours
Power Consumption*7	Approx. 10 W *8/ Approx. 30 W (Maximum when recharging in the ON state)	
Physical Dimensions (W × H × D)	267 mm × 208 mm × 36 mm (excluding protrusion) {10.5" × 8.2" × 1.4"}	
Weight	Approx. 1.2 kg {Approx. 2.6 lb.}	
Operation Environment	Temperature: 5 °C to 35 °C {41 °F to 95 °F} Humidity: 30% to 80% RH (No condensation)	
Storage Environment	Temperature: -20 °C to 60 °C {-4 °F to 140 °F} Humidity: 30% to 90% RH (No condensation)	
Operating System	Microsoft® Windows® CE 5.0 Professional	

Software	Microsoft® Remote Desktop Connection, Citrix® ICA® Client, Microsoft® Internet Explorer 6.0
----------	---

- \*1 This slot does not support the MultiMedia card.  
Operation has been confirmed for Panasonic SD Memory Cards with up to 2 GB capacity.
- \*2 Theoretical value and not the actual speed. The transfer rate does not become higher even if you use a card that supports the higher transfer rate.
- \*3 <Only for North America>  
The AC adaptor is compatible with power sources up to 240 V AC adaptor. The wireless display is supplied with a 125 V AC compatible AC cord.
- \*4 Varies depending on the usage conditions.
- \*5 Measured using BatteryMark™ Version 4.0.1 (LCD brightness: Maximum - Minimum)
- \*6 Measured using MobileMark™ 2002 (LCD brightness: 150 cd/m<sup>2</sup>)
- \*7 Approx. 0.9 W when the battery pack is fully charged (or not being charged) and the wireless display is OFF.
- \*8 Rated power consumption

## ■ Wireless LAN

Data transfer rates* <sup>9</sup>	11/5.5/2/1 Mbps (automatically switched)
Standards supported	IEEE802.11b
Transmission method	OFDM system, DS-SS system
Wireless channels used	Channels 1 to 11
RF frequency band	2412-2462 MHz

- \*<sup>9</sup> These are speeds specified in IEEE802.11b standards. Actual speeds may differ.

## ■ Bluetooth™

Bluetooth Version	1.2
Transmission Method	FHSS system
Wireless Channels Used	Channels 1 to 79
RF Frequency Band	2.402-2.48 GHz

# LIMITED WARRANTY

For U.S.A.

## **PANASONIC PERSONAL COMPUTER AND PERIPHERALS LIMITED WARRANTY**

Panasonic Computer Solutions Company (referred to as "Panasonic") will repair this product (other than software, which is covered by a separate warranty) with new or rebuilt parts, free of charge in the U.S.A. for three (3) years from the date of original purchase in the event of a defect in materials or workmanship. This warranty includes the AC adaptor but excludes the batteries and all other options and accessories which are covered for a period of one (1) year from the date of purchase.

This warranty is extended solely to the original purchaser. A purchase receipt or other proof of date of original purchase will be required before warranty performance is rendered.

This warranty only covers failures due to defects in materials or workmanship which occur during normal use. It does not cover damage which occurs in shipment or failures which are caused by products not supplied by Panasonic, or failures which result from alteration, accident, misuse, introduction of liquid or other foreign matter into the unit, abuse, neglect, installation, maladjustment of consumer controls, improper maintenance, modification or service by anyone other than a Factory Service Center or authorized Panasonic Service Dealer, or damage that is attributable to acts of God.

### **Limits and Exclusions:**

There are no other express warranties except as listed below.

PANASONIC SHALL NOT BE LIABLE FOR LOSS OF DATA OR OTHER INCIDENTAL OR CONSEQUENTIAL DAMAGES RESULTING FROM THE USE OF THIS PRODUCT, OR ARISING OUT OF ANY BREACH OF THIS WARRANTY. ALL EXPRESS AND IMPLIED WARRANTIES, INCLUDING THE WARRANTIES OF MERCHANTABILITY AND FITNESS FOR A PARTICULAR PURPOSE ARE LIMITED TO THE APPLICABLE WARRANTY PERIOD SET FORTH ABOVE. Some states do not allow the exclusion or limitation of incidental or consequential damages, or limitations on how long an implied warranty lasts, so the above limitations or exclusions may not apply to you.

This limited warranty gives you specific legal rights, and you may also have other rights which vary from state to state. If a problem with your product develops during or after the warranty period, you may contact our representatives at 1-800-LAPTOP5. If the problem is not handled to your satisfaction, then write to the Consumer Affairs Division at the address indicated on the next page.

## **SOFTWARE LIMITED WARRANTY**

Panasonic Computer Solutions Company (referred to as "Panasonic") warrants to you only that the disk(s) or other media on which the Programs are furnished will be free from defects in materials and workmanship under normal use for a period of sixty (60) days from the date of delivery thereof to you, as evidenced by your purchase receipt.

This is the only warranty Panasonic makes to you. Panasonic does not warrant that the functions contained in the Programs will meet your requirements or that the operation of the Programs will be uninterrupted or error free.



Panasonic's entire liability, and your exclusive remedy under this warranty shall be limited to the replacement, in the United States, of any defective disk or other media which is returned to Panasonic's Authorized Service Center, together with a copy of the purchase receipt, within the aforesaid warranty period.

Anything in the foregoing to the contrary notwithstanding, Panasonic shall have no obligation for any defects in the disk(s) or other media on which the Programs are furnished resulting from your storage thereof, or for defects that have been caused by operation of the disk(s) or other media otherwise than on the Product or in environmental conditions other than those specified by Panasonic by alteration, accident, misuse, abuse, neglect, mishandling, misapplication, installation, maladjustment of consumer controls, improper maintenance, modification of damage that is attributable to acts of God. In addition, Panasonic shall have no obligation for any defects in the disk(s) or other media if you have modified, or attempted to modify any Program.

DURATION OF IMPLIED WARRANTIES, IF ANY, IS LIMITED TO SIXTY (60) DAYS.

PANASONIC ASSUMES NO RISK OF AND SHALL NOT IN ANY CASE BE LIABLE FOR ANY DAMAGES, INCLUDING, WITHOUT LIMITATION, ANY SPECIAL, INCIDENTAL, CONSEQUENTIAL, OR PUNITIVE DAMAGES ARISING FROM BREACH OF WARRANTY OR CONTRACT, NEGLIGENCE OR ANY OTHER LEGAL THEORY, INCLUDING, WITHOUT LIMITATION LOSS OF GOODWILL, PROFITS OR REVENUE, LOSS OF USE OF THE PROGRAMS OR PRODUCTS OR ANY ASSOCIATED EQUIPMENT, COST OF CAPITAL, COST OF ANY SUBSTITUTE EQUIPMENT, FACILITIES, SERVICES, DOWNTIME COSTS, OR CLAIMS OF ANY PARTY DEALING WITH YOU FOR SUCH DAMAGES.

Some states do not allow the exclusion or limitation of incidental or consequential damages, or limitations on how long an implied warranty lasts, so the above limitations or exclusions may not apply to you.

This limited warranty gives you specific legal rights, and you may also have other rights which vary from state to state.

This Limited Warranty will be governed by the laws the State of New York, without regard to its conflict-of-laws rules.

\* \* \*

To obtain service or technical assistance within the continental U.S.A. and Alaska.

**DIAL TOLL FREE: 1-800-LAPTOP5**

Correspondence requesting product information should be sent to:  
Panasonic Computer Solutions Company  
50 Meadowlands Parkway, Panazip 2F-5, Secaucus, NJ 07094

# LIMITED WARRANTY

## For Canada

### **PANASONIC COMPUTER AND PERIPHERALS LIMITED WARRANTY**

**Coverage** – Panasonic Canada Inc. (“PCI”) warrants to you, the first end user customer, this computer product (excluding software media), when purchased from PCI or from a PCI authorized reseller, to be free from defects in materials and workmanship under normal use, subject to the terms set forth below, during the period of warranty coverage specified.

Scope of Coverage	Period of Coverage	Type of Failure Coverage
Whole Product (except Batteries), AC adaptor and CD-ROM (if factory installed)	Three (3) Years from Date of Original End User Customer Purchase	Defective Materials or Workmanship
Batteries, CD-ROM (unless factory installed), Port Replicator, Extra Memory Modules and all other Peripherals, Options and Accessories	One (1) Year from Date of Original End User Customer Purchase	Defective Materials or Workmanship

**Remedy** – In the event of a warranty claim, contact PCI’s representatives within the applicable warranty period, identifying the nature of the defect claimed, at 1-800-668-8386 between 9:00 A.M. and 5:00 P.M., Eastern Time Zone, Mon. – Fri. (excluding holidays) for instructions on how to obtain service. A purchase receipt or other proof of date of original purchase is required before warranty service is performed. Defective parts covered by this Limited Warranty will be repaired or replaced with new or comparable rebuilt parts on an exchange basis. Warranty replacement or repair is subject to the terms of this Limited Warranty for the balance of the original period of warranty coverage.

**No Coverage** – This Limited Warranty does not cover products purchased outside Canada. Neither does it cover damage to, failure of, or defects in a product or accessory through mishandling, improper installation, abnormal use, misuse, neglect, accident, introduction of liquid or other foreign matter into the product, alteration or servicing by anyone not authorized by PCI, or act of God.

#### **IF YOU SHIP THE PRODUCT FOR WARRANTY SERVICE**

Carefully pack the product, preferably in the original carton. Include details of defect claimed and proof of date of original purchase. No liability is assumed for loss or damage to the product while in transit, if you chose your own transportation carrier.

### **SOFTWARE MEDIA LIMITED WARRANTY**

**Coverage** – Panasonic Canada Inc. (“PCI”) warrants to you, the first end user customer, that the disk(s) or other media on which software program(s) is/are supplied will be free from

defects in materials and workmanship under normal use in Canada for a period of sixty (60) days from date of receipt as evidenced by your purchase receipt for your Panasonic Computer product.

THIS IS THE ONLY WARRANTY THAT PCI MAKES RESPECTING THE SOFTWARE MEDIA. PCI does not warrant the software. Please refer to the software licensor's written warranty (accompanying the copy of the software) for any software warranty claim.

**Claim Procedure** – In the event of a defect in material or workmanship in the media during the sixty (60) day warranty period, and you return it, transportation costs prepaid, to Panasonic Canada Inc., Computer Products Marketing, at the above address, within the warranty period, together with a copy of your purchase receipt, and an explanation of the suspected defect, PCI will replace in Canada the defective disk(s) or other media.

**Remedy** – PCI's entire liability, and your only remedy for any breach of this software media warranty is limited to replacement of the media only. It does not cover any other damages, including, but not limited to, loss of use or profit loss, or special, indirect or consequential damages, or other claims, whether or not of similar character.

**No Coverage** – This limited warranty does not apply if the disk(s) or other media has been used in other than a Panasonic product, or in environmental conditions other than those specified by PCI or the manufacturer, or if subjected to misuse, neglect, mishandling, modification or attempted modification of the program, or if damaged by accident or act of God. PCI is not responsible for damage to or loss of any program, data or removable storage media.

## **GENERAL**

NO OTHER WARRANTIES – PCI DISCLAIMS ALL OTHER WARRANTIES, EITHER EXPRESS OR IMPLIED, INCLUDING, BUT NOT LIMITED TO, IMPLIED WARRANTIES OF MERCHANTABILITY AND FITNESS FOR A PARTICULAR PURPOSE, WITH RESPECT TO THE SOFTWARE, SOFTWARE MEDIA, COMPUTER PRODUCT, OPTIONS AND ACCESSORIES.

NO LIABILITY FOR CONSEQUENTIAL DAMAGES – IN NO EVENT SHALL PCI BE LIABLE FOR ANY SPECIAL, INDIRECT OR CONSEQUENTIAL DAMAGES ARISING FROM ANY BREACH OF THE LIMITED WARRANTIES SET OUT IN THIS DOCUMENT, OR FROM THE USE OF THE COMPUTER PRODUCT, INCLUDING, WITHOUT LIMITATION, LOSS OF DATA, BUSINESS, PROFIT OR GOODWILL.

IN ANY EVENT, PCI'S MAXIMUM LIABILITY FOR ANY BREACH SHALL NOT EXCEED THE AMOUNT ACTUALLY PAID BY YOU FOR THE COMPUTER PRODUCT.

NO ACTION, REGARDLESS OF ITS BASIS, MAY BE BEGUN AGAINST PCI MORE THAN TWO (2) YEARS AFTER THE CAUSE OF ACTION AROSE.

**Statutory Warranties** – Some jurisdictions do not allow these limitations or exclusions, so they may not apply to you.

**Panasonic Computer Solutions Company**

50 Meadowlands Parkway, Panazip 2F-5,  
Secaucus, NJ 07094

**Panasonic Canada Inc.**

5770 Ambler Drive Mississauga,  
Ontario L4W 2T3

Importer's name & address pursuant to the EU GPSD directive 2001/95/EC/Art.5

**Panasonic Computer Products Europe, Panasonic Marketing Europe GmbH**

Hagenauer Straße 43  
65203 Wiesbaden  
Germany

© 2006 Matsushita Electric Industrial Co., Ltd. All Rights Reserved.  
Printed in Japan

FJ0406-0  
DFQX5591ZA

